

# **Easier and More Productive Study and Desk Work**

AMIEL W. FRANCKE, O.D. &  
WALTER J. KAPLAN, O.D.

# Easier and More Productive Study and Desk Work

---

## ABSTRACT

*This article is a uniquely optometric public service. Working from an optometric model of vision, the authors collected and condensed extensive information from many professions and scientific fields, developed additional material, field-tested the information, and created an original, easy-to-apply handbook to help the very large segment of the population that does near tasks. Only an optometric model of vision can tell us how near tasks produce a general tightening of the musculature and undesirable changes in visual status, which in turn lower efficiency at near tasks; and that the way to counteract this process is to have minimal obstructions to movement at such tasks (thus, the information on chair and table design, shoes, etc.) Only an optometric model of vision makes us aware of the value of breaks to offset tightening, and tells us when to take breaks, what to do during breaks, and specific exercises to reduce near task stress. Only an optometric model tells us that the lighting which others consider adequate is often excessive and leads to fatigue, and allows us to determine the proper amount of lighting in general and for the individual. And only an optometric model of vision tells us of the value of adjustable arm typing stands. Because of its approach, "Easier and More Productive Study and Desk Work" reinforces the view of optometry as a broad-based discipline which relates vision to all areas of human performance.*

## KEY WORDS

*near vision, vision performance, near task stress, illumination, posture, productive study*

---

As a student doing schoolwork, an office worker engaged in paper work, typing or program planning, or a citizen preparing an income tax return, you periodically apply yourself to the visual tasks of reading, writing and typing. By doing these tasks productively, you can make your life considerably easier and more enjoyable. Productive study and desk work are not only a matter of how much time you spend working but also how efficient you are during that time. Working many hours at low efficiency produces little. This article used an optometric model of vision to help you organize the conditions under which you read, write and type to make your work time as productive as possible.

It would be ideal if you could immediately implement all the suggestions in this paper, but generally that is not possible. A realistic, effective way to utilize this material is to read it all the way through, and then apply to your present work situation the one or two ideas which seem most useful. A student may start with a reading board or a different kind of chair. A typist may want to experiment with a better copy-holder, a draftsman with better lighting.

Over a period of time, you can make other changes. As you gradually begin to improve the conditions under which you work, you will find your work becoming easier and you will be more productive.

## Timing your work

### WHEN TO WORK

*Regularity:* A regular schedule psychologically prepares you to work at a certain time each day. Design daily schedules as much alike as possible. If you cannot work at the same time each day, plan a weekly schedule. Although your requirements for work time will not be the same each day or week, a schedule permits you to have a maximum productive time available. If all your scheduled time is not required, you will have the unused time free for other interests.

*Time of Day:* Although the image of the student working into the wee hours is an appealing one, experience shows that people are most productive between sunrise and sunset. Early morning is the most desirable time to do desk work; late evening is the least desirable. Very few people really work effectively after a day's activities and aggravations. The image of the student probably had its origin in the recognition of a student's need for undisturbed privacy. Arranging privacy to coincide with periods of optimum biological efficiency (early morning or daytime) instead of lowest biological efficiency (late evening) will insure good utilization of work time.

Of course, many people must work within prescribed hours. Perhaps you have classes all day or work between noon and eight o'clock at night. In such cases, try to do your most important tasks in

the beginning of your scheduled work time.

**Not After Meals:** After eating, your heart increases its work-load to supply blood to your digestive tract. Since digestion consumes energy, most people do not work well right after a large meal. Schedule some free time immediately after meals if possible.

**LENGTH OF TIME TO WORK**

How long you work at one time will affect how productively you work. The length of time you can concentrate varies with individuals and with age. Generally, elementary students can concentrate on a task for about 20 minutes, intermediate students, about 30 minutes, and high school students, 40 minutes. By the time they are adults, people usually have a concentration span of 45-50 minutes. It is important to experiment and determine your individual duration. Stop before you feel tired, take a break and then resume work.

**TAKING BREAKS**

If you continue one unbroken work period until you are tired, the quality and quantity of your work will decline and you will recover slowly. If you stop before you are fatigued, you will recover more quickly and do more and better work. A reasonable ratio of task time to break time for an adult for a full work day is:

Task time. . . . .	45 min.	.....	Break time. . . . .	15 min.
Task time. . . . .	45 min.	.....	Break time. . . . .	30 min.
Task time. . . . .	45 min.	.....	Break time. . . . .	15 min.
Task time. . . . .	45 min.	.....	Break time. . . . .	60 min.
Task time. . . . .	45 min.	.....	Break time. . . . .	15 min.
Task time. . . . .	45 min.	.....	Break time. . . . .	30 min.
Task time. . . . .	45 min.	.....	Break time. . . . .	15 min.
Task time. . . . .	45 min.	.....	Break time. . . . .	15 min.
Total			Total	
Task Time	6 hrs.		Break time	2 hrs

This allows for six productive hours in an eight-hour work day, considerably more productive time than is usually available to the average student or office worker.

If you are working for only part of the day, shorter breaks may be adequate. A good solution is to start with 15- and 30-minute breaks, and gradually modify them until you determine what is best for you.

**WHAT TO DO DURING A BREAK**

Tension, which is a tightening of your muscles, interferes with productive work. Tight muscles obstruct good blood circulation and thus make you tired. You can produce tension in several ways: physically, by simply holding any one posture without a variety of movements; or mentally, by concentrating on reading, writing or other desk work. The more your work area restricts movement or your work demands understanding or accuracy, the more tension will be created.

---

***"If you continue one unbroken work period until you are tired, the quality and quantity of your work will decline and you will recover slowly. If you stop before you are fatigued, you will recover more quickly and do more and better work."***

---

You will restore good circulation and reduce fatigue by moving, stretching and loosening your muscles. If you are working at home, you can use your breaks to do some personal or household chore that involves movement. If you are working at the office or library, a brisk walk around the block or the building is a good way to loosen up. A walk or some simple exercise returns you to the task more refreshed and productive than sitting and drinking coffee. Walking at lunchtime will re-energize you for the afternoon's work.

*Taking a break does not necessarily mean you must interrupt your train of thought. If you have a high degree of interest in your material, you can continue to think as you temporarily*

*leave your desk and move around.*

Specific exercises you can do during your breaks are listed at the end of this paper.

If it is impossible to leave your desk, stretch your muscles by wiggling your toes, moving your legs and arms, or pulling in your stomach.

**VARYING SEQUENCE OF TASKS**

Varying your tasks so that each task uses different sets of muscles, or the same muscles in a different way, will enable the muscles to have a longer recovery period before being used again. If you have reading, writing, filing and typing tasks, for example, alternate them during the work period, with breaks in between. In this way, you will reduce your fatigue and work more productively for a longer period of time.

Although the best performance is attained by the greatest variety of tasks, many people cannot easily leave one task and move to a new one. If you cannot vary the type of task, it will help if you change your posture or rearrange the materials with which you are working.

**Arranging the work area**

**WHERE TO WORK**

If you are working at home, try to do most of your desk work in one location. This permits you to arrange the area for maximum effectiveness and establishes in your mind that when you come in to this area you are going to work.

**POSITION OF WORK AREA**

A good work area faces into open space, not toward a wall. If you are facing an open space, every time you look up you will focus your eyes at a distance different from your working distance. Changing the focus of your eye reduces tension and fatigue. Avoid facing a very bright open space; the glare of direct sunlight or neon lights will contrast too sharply with your own work area and prove distracting.

**VENTILATION**

Everyone studies better with adequate fresh air. You do not work effectively when the air is stale and lacking in oxygen.

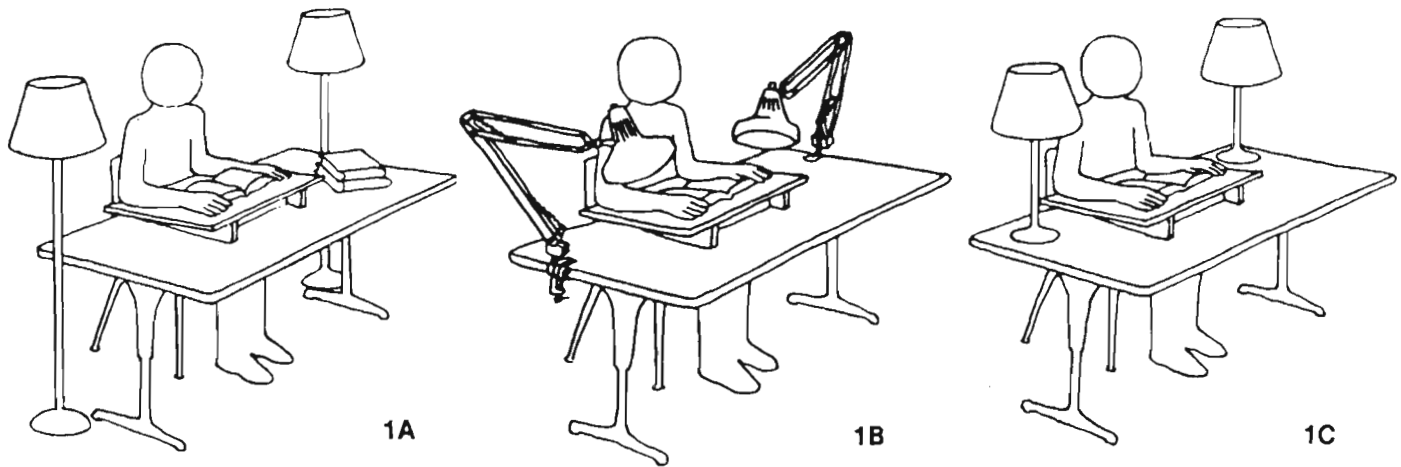

ILLUSTRATION 1

Place two lamps equidistant from the sides of your work area. They should be just far enough forward so that your body does

not cast any shadows on your work.

### TEMPERATURE

So many variables--your clothing, sex, level of physical activity, the humidity--affect comfortable room temperature that no one temperature is desirable for everyone. Keeping in mind that most people work best in a slightly cool room, you can quickly discover what temperature is best for you. Very few people work well in either a very hot or very cold room.

### CLOTHING

Wear comfortable, loose clothing for study and desk work. Your garments should not bind in any way.

People often work off muscle tension by flexing their feet and toes. Since many shoes do not allow for this, you may work better without shoes.

### SOUND

Select an area where you will not be bothered by interruptions or distractions. You do not want a completely quiet area; complete silence can be as diverting as excessive noise. The best arrangement is some low level of undifferentiated sound, just loud enough to mask variations in the noise level. A radio in the next room playing soft music or the hum of an air conditioner will provide the right level of sound.

### LIGHTING

*Placement of light source:* The best type of lighting is overall indirect illumination which produces enough shadows and contrasts throughout the room to avoid a monotonous appearance. You can achieve this in several ways.

1. The ideal way is to illuminate the whole area by using an overhead two- or four-tube fluorescent fixture with four-foot-long tubes. Vita-Lite and Verilux fluorescent tubes are probably the best on the market, as they most closely approximate natural lighting. Although they are initially expensive, they last considerably longer than regular fluorescent tubes. Vita-Lite is made by Duro-Test, North Bergen, New Jersey 07047, and Verilux is made by Verilux, Inc., 35 Mason Street, Greenwich, Connecticut 06830. Write to the factories to find out where you can buy them locally.

If you do not use Vita-Lite or Verilux, use "warm white" tubes. (Do not accept any other color, including "deluxe warm white.") Select a plastic or metal eggcrate shield, which directs the light down through openings in the shield. If you cannot find an eggcrate shield, use bare tubes rather than solid sheets of plastic, which absorb light and change its color.

An overhead fluorescent fixture is preferable to incandescent work lamps. The fluorescent fixture not only illuminates the work area but adequately lights the rest of the room as well. Fluorescent light also generates less heat than incandescent light.

2. Two floor lamps, one placed on each side of the table, can light the work area. (Ill. 1A) Be sure that the lamps' height is such that you are not distracted by the glare at the bottom of the shade. An opaque shade will prevent your seeing a bright spot where the light penetrates the shade.

3. Because they occupy desk space and are distracting, desk lamps are the least desirable lighting. If you must use desk lamps, try to use lamps with arms that can be adjusted to meet your needs. (Ill. 1B) These lamps frequently come in a clamp-on model which occupies minimum desk space. If you use ordinary desk lamps, place one on each side of your work table. (Ill. 1C)

High intensity lamps provide too much illumination, too much contrast and overly sharp vision and are consequently quite fatiguing. Do not use them.

*Amount of illumination:* Usually the younger you are, the less illumination you require. Most people need between 50 and 100 footcandles (the standard measure of light). Your electric company

representative or a light fixture salesperson might recommend more. But more lighting, while producing sharper vision, generates tension and more quickly fatigues you.

Variables like the amount of reflected light in the room make it difficult to predetermine what lamp at what distance will give you the proper amount of light. You must experiment to find out how much illumination meets your individual needs. To determine your optimum amount, start with 50 footcandles--a moderate amount of light--and see if it feels comfortable; if not, gradually increase it until you find a comfortable amount. Do not begin with a high number of footcandles and then start to reduce it. You will end up with too many footcandles. The sharp vision will appeal to you but ultimately will be very fatiguing.

The amount of illumination can be varied in several ways. If you are using floor or desk lamps, you can change the size of the bulbs or move the lamps closer to or farther from your work area. Some overhead fluorescent fixtures can be lowered or raised.

Illuminate the rest of the room, but not as brightly as the work area. When you are testing the amount of light at your work area, be sure you have the rest of the room illuminated as it will be when you are working. If you want to measure footcandles, you can use a photography light meter or your local electric company will generally send someone out to help you.

### CHAIRS

A well-designed chair which is the correct height for you makes it easier to maintain good posture while doing desk work. It also allows freedom of movement, an important way of preventing and working off tension.

Proper design promotes good posture by encouraging you to carry the weight of your trunk on your ischial tuberosities, not on the base of your spine or on your thighs. (Ill. 2) Well-designed chairs help distribute your weight over the buttocks and thighs by having a depression in the rear to house the buttocks. A chair

designed without struts or obstructions between the front legs permits you to shift position easily.

Proper height allows you to move your legs about freely. If your chair is too high, your feet do not touch the ground; then all the weight of your legs rests on your thighs, making it difficult to move your legs about. If the chair is too low, it pushes your knees up into the air, makes it hard to move your legs and forces your spine to carry your weight.

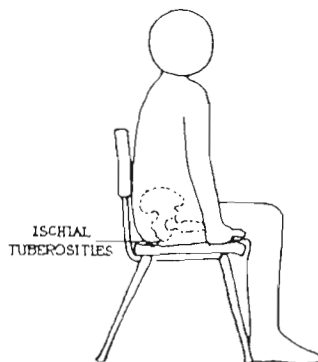

ILLUSTRATION 2

The proper height for your chair can only be determined while sitting in a chair with your feet straight down on the floor. Many shoes, both men's and women's, have an inch or more of height in the heel. This raises the position of the thigh relative to the chair, a critical factor in determining proper chair height. Therefore, test the chair using the same type of footwear--or no footwear at all--that you will be wearing when you are actually working. Try to slide your hands (palms up) between your thighs and the chair. (Ill. 2) If the chair is the right height, your hands will slide through with minor friction and difficulty. If the chair is too high, it will take considerable pushing to get your hands through. If the chair is too low, your hands will slide through with little or no difficulty.

If your legs are short, or if for other reasons you cannot arrange proper chair height, you can rest your feet comfortably on a box or some telephone books.

Chairs that are adjustable or are supposed to grow with the student

generally do not maintain the proper proportion of the chair's back to its height and seat size as you readjust the parts. The best chairs available are standard classroom chairs which come in nonadjustable, proportioned sizes. You can purchase this type of chair through school furniture supply sources. Since these outlets usually deal in large quantities, the salespeople may not be enthusiastic about selling an individual chair, but they will if you persist. If this type of chair is absolutely unobtainable, in order of preference, consider either a straight-back wooden chair modified to the correct height (generally by sawing off the legs) or a standard secretarial chair.

### DESKS AND TABLES

Tables are preferable to desks because tables are less expensive, more adaptable and more likely to have the desired features. Most desks and some tables confine your leg movement, prohibiting you from working off tension. Properly designed desks and tables have undersides free of cross struts, bookholders or drawers other than very shallow ones, thus providing ample space to move your legs. A table which can be adjusted for height and is about two feet deep by three feet wide works well for most people. A larger table is certainly desirable if you have the available space.

An adjustable table will serve most people from childhood through adulthood. Adjust the table so that it is at elbow height with your arms in the position shown in Illustration 3 when you are seated in a properly designed chair which is the right height for you. Adjustable height tables are available through school furniture supply stores. If they are not easily obtainable, you can inexpensively make your own adjustable table by purchasing an unfinished hollow core wooden door at any lumber yard and propping it up to the desired height. If necessary, you can shorten the legs of a standard wooden table.

Make sure the surface of the table is comfortable to write upon and is nonreflecting to minimize glare. The color of the surface should be as close as

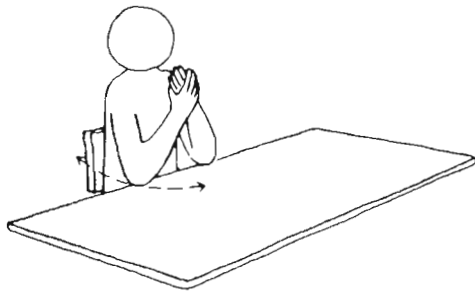

ILLUSTRATION 3

Lay one palm in the other in this position. When you swing your arms, your elbows should just clear the top of the table.

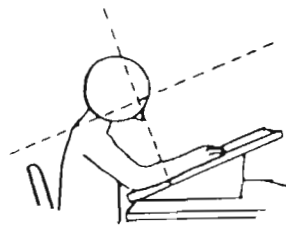

ILLUSTRATION 4

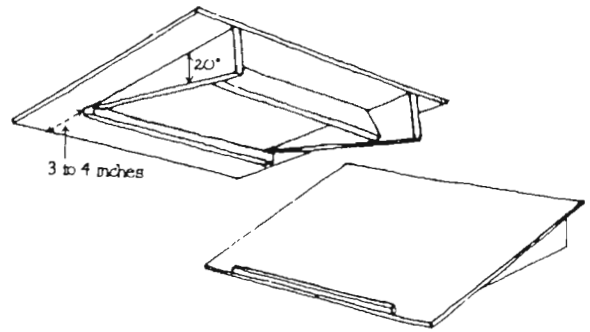

ILLUSTRATION 5

The overall size of the inclined work surface can vary from 14 inches deep by 21 inches wide to 2 feet deep by 3 feet wide. The larger size is preferable. All standard inclined surfaces have an angle of 20 and a 3-4 inch overhang. Shorter people will prefer a three inch overhang; taller people will prefer a four inch overhang. Cover the contact points with felt to prevent marring of the desk.

possible to the color of the palm of your hand. An easy, economical way to provide a nonreflecting comfortable writing surface is to cover the table with a large blotter approximately the color of your palm. Large blotters can be purchased from any office supply or commercial stationery store.

Many school furniture manufacturers make tables with all these features.

#### USING AN INCLINED WORK SURFACE

Whether working with paper and pen or reading, the plane of your face should be parallel--or as nearly parallel as possible--to the plane of the material. Illustration 4 shows the proper position of your face relative to your eyes at an approximately equal distance from the material and thereby minimizes stress.

An inclined work surface similar to the following design encourages you to assume this position naturally.

It can be built by any lumber or mill yard or cabinet maker--or you can build it yourself. Match the surface to the color of the palm of your hand: if you are white, use unfinished birch plywood; if you are brown or black, use a slightly darker plywood. No finish of any sort should be applied to the wood. The

natural wood will not reflect glare and will prevent a piece of paper from sliding. When the surface gets dirty, a light sanding with fine sandpaper will restore it.

Inclined work surfaces are most helpful for reading, writing and drawing tasks. They are not as helpful when the task requires manipulation of objects or many pieces of paper. Although the inclined surface makes work easier for the majority of people, some people find it good for one task but a hindrance for another. If, after trying it for several weeks, the surface is hampering your reading or writing (or both), use it only for those tasks it makes easier for you.

Generally, the combination of an adjustable table with an inclined surface is more satisfactory than a tilt-top desk or drafting board for several reasons:

***"Taking a break does not necessarily mean you must interrupt your train of thought. If you have a high degree of interest in your material, you can continue to think as you temporarily leave your desk and move around."***

1. It is very hard to find a tilt-top desk with sufficient work area and without props, struts or cross bars that interfere with leg movement.

2. Some tilt-top desks come with attached chairs and frequently either the chair or desk is the wrong size.

3. By using a combination of table and separate inclined work surface, you can have the best of both an inclined and flat surface and can change from one to the other quickly and easily.

4. Young people always outgrow the commercial tilt-top desk, whereas one adjustable table and one inclined work surface will last throughout an academic career.

#### STAND-UP WORK AREAS

Many people who have to do paper work or read and study all day find that by changing their posture from sitting to standing several times throughout the day, they increase their productivity and reduce fatigue. An adequate work area for standing should incorporate all the features of the sitting work area. (Ill. 6) A footrest will allow you to work for a while with both feet on the ground and then change position by raising a foot. Alternating which foot you raise is helpful. If your stand does not have a built-in footrest, you can use a low box.

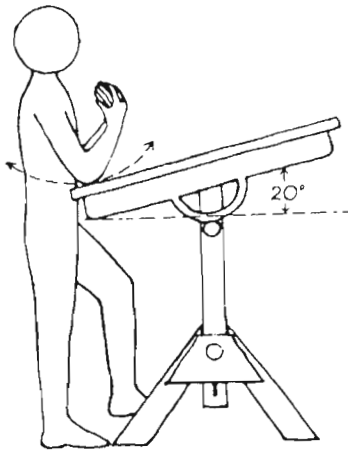

**ILLUSTRATION 6**

With one palm in the other, your elbows should contact the work surface 3-4 inches from its edge.

**HOW TO POSITION YOURSELF AND YOUR WORK**

Your most comfortable and efficient posture for working with paper and pen is determined by your preferred hand and your preferred eye. You already know whether you are right- or left-handed. To determine your preferred eye, roll a sheet of paper into a narrow tube no more than an inch in diameter. Hold it with both hands at arm's length. Sight something through it with both eyes, and then without moving the tube, alternately close your eyes. You will find that only one eye is sighting the target through the tube. That is your preferred eye. Then position the paper and rotate your body and head according to Illustration 7.

**TYPING TABLES**

Proper conditions for typing are as important as proper conditions for reading and writing, especially for those people who spend part of their day typing. Your typing chair should be the same type and height as the one used for reading and writing. Your typing table should be three inches lower than your work table which has been adjust to your height. Typing tables which have cross braces and a narrow leg space restrict movement. Those which are free of cross struts and have plenty of room in all directions allow you to move your legs around and work out the kinks.

**PLACEMENT OF MATERIAL FOR TYPING**

The most stressful way to type is with your copy material beside your typewriter. Your body is pointing straight ahead at the typewriter, with your head and eyes turned to one side. This causes eye, neck, shoulder and back stress. If you must type this way, reduce the stress as much as possible by frequently changing the position of your copy from one side to the other.

The most efficient and least stressful method of typing is with your copy squarely in front of you, above your typewriter and slightly below eye level. Then your body, head and eyes are all pointing in the same direction with your face and copy paralleled and you are in the position of minimum stress. You can best accomplish this with the Oxford Copyholder Number 551 or some other adjustable copyholder. Their adjustable arms permit you to put the material directly in front of you at the distance most comfortable for you. Adjustable copyholders are a good investment if you type as much as an hour per day. They are especially helpful if you have difficulty changing the focus of your eyes from one distance to another, or if you use a special pair of eyeglasses for typing and need to have both your copy and the page in your typewriter at the same distance from you. The current cost of the Oxford copyholder is \$45, but it is well worth it. Adjustable copyholders are available through most commercial office supply or stationery stores.

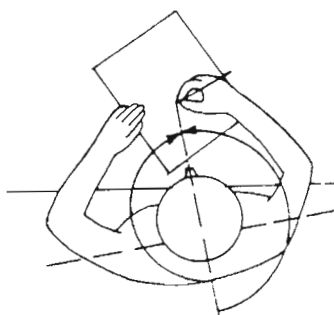

**Left eye preferred  
Right handed**



**Right eye preferred  
Left handed**

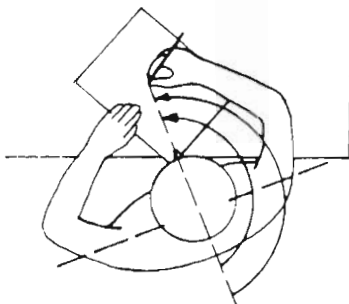

**Right eye preferred  
Right handed**

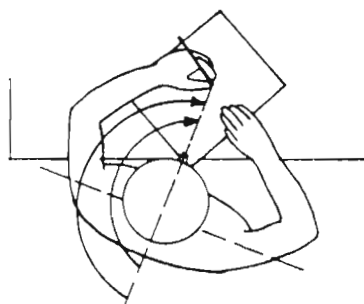

**Left eye preferred  
Left handed**

**ILLUSTRATION 7**

The long arrow shows how to rotate your body and the short arrow shows how to rotate your head.

## FREEDOM FROM CLUTTER

Clutter is distracting and inhibits physical movement. Only the books and papers in use should be on your work surface. Place all other equipment and books on a nearby table or bookcase.

Again, your work situation does not have to be perfect. You may not be able to adjust every factor to allow for maximum productivity. However, the more you can use the preceding information, the more productive you will be.

### Exercises

Here are some exercises you can do during your breaks. Do all of them several times until you are sure you understand them. Then select those that are best for you.

Never exert yourself to the point of pain; these exercises are designed to comfortably stretch your body.

1. Bend over with your knees bent and your feet comfortably apart, let your arms and head dangle. (You will be looking through your legs.) Then, swing your arms 10-20 times or more:

- front to back easily and loosely
- side to side easily
- in a circle easily; go in both directions.

2. General twisting and turning. Do each of the following until you feel comfortable.

- Stand on your toes, look straight ahead and reach for the ceiling.
- Bend over, dangling your arms and head. (You will be looking through your legs.) Bounce up and down a few times from the waist.
- Stand with your feet apart and spread out your arms parallel to the ground. Swing your body at the waist from one side to the other, right to left, several times. Look at the hand leading the way.
- Stand straight. Let your arms dangle freely and slowly roll your head in a circle to reduce the tension in your neck. Roll it clockwise and then counterclockwise.



1A



1B

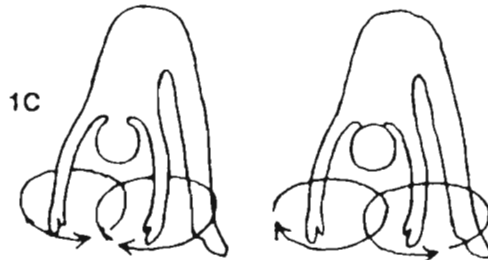

1C

Exercise 1



2A

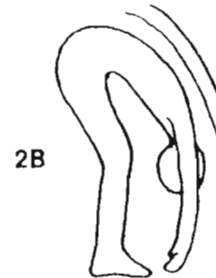

2B



2C

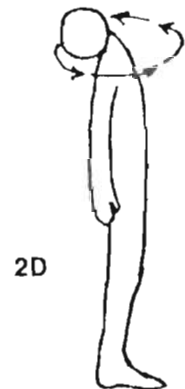

2D

Exercise 2

3. Lie on your back with your feet on the ground, your knees in the air and your arms loosely at your sides. Try to simultaneously flatten the small of your back and neck against the ground as much as you can. You will feel as if you are making your body longer. Repeat several times for one to two minutes.

4. Stand with your back against a wall with your knees slightly bent and your feet 6-18 inches from the wall. Try to simultaneously flatten your back and neck against the wall as much as you can. Repeat for one to two minutes. As you improve, bring your feet closer to the



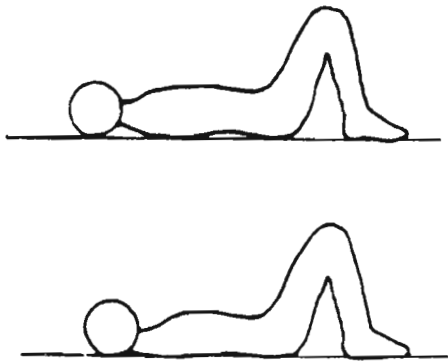

**Exercise 3**

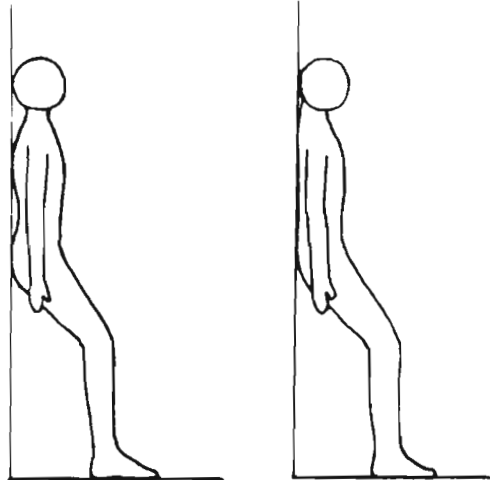

**Exercise 4**

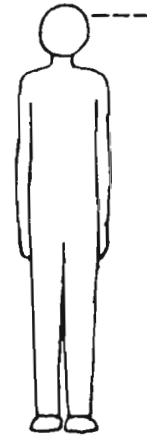

**Exercise 5**

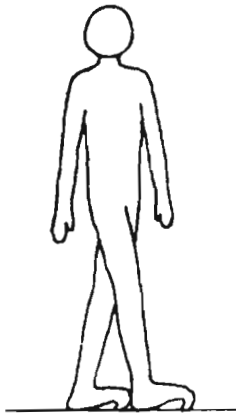

**Exercise 6**

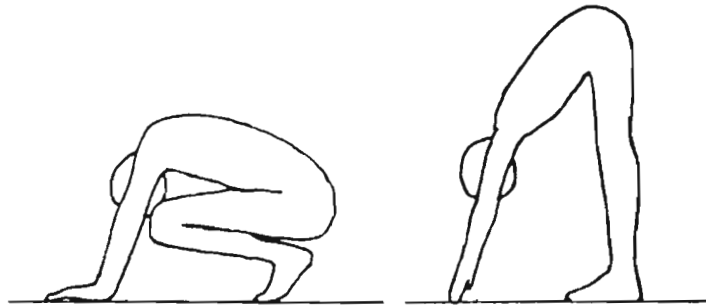

**Exercise 7**

wall.

5. Without raising your shoulders or your chin, stand as tall as you can. Mark your height on the wall or some other object. Then try to stand taller. Repeat several times.

6. Take off your shoes. Curl all your toes under each foot as far as you can and walk a straight line, placing one foot directly in front of the other so that the heel touches the toes. Look straight ahead. Try to walk a straight line, heel to toe, heel to toe for 10-20 steps. As you improve, curl your toes further under and increase the number of steps.

7. Crouch on the floor resting on your toes with your heels in the air and your hands flat on the floor about 12 inches in front of you. Let your head dangle. (You will be looking through your legs.) Keeping the tips of your fingers on the floor, rise up slowly putting your heels on the floor and straightening your knees.

Rise only as far as you can comfortably go. Repeat 10-15 times, remembering to let your head dangle. As you improve, keep your knuckles on the floor; then the palms of your hands. When you can do this comfortably, move your hands closer to your feet. **AOA**

Submitted for publication in the *Journal of the American Optometric Association* in 3/77.

#### **Additional Reading**

Abramson, DI. *Circulation in the extremities*. New York: Academic Press, 1967  
 Architectural Research Laboratory. *School Environments Research*. Nos. 1-2. Ann Arbor, Mich.: University of Michigan, 1965

Bird, C. *Effective study habits*. New York: Century Co., 1931  
 Book, WR. *Learning how to study and work effectively*. Lexington, Mass.: Ginn & Co., 1926.

Broer, MR. *Efficiency of human movement*. Philadelphia: W.B. Saunders Co., 1966.

Cohen, LA. Mechanisms of perception: their development and function, in American Association for Health, Physical Education, and Recreation. *Perceptual-motor foundations: a multidisciplinary concern*. Washington, D.C.: American Association for Health, Physical Education, and Recreation, 1969, pp. 23-48.

\_\_\_\_\_. Role of eye and neck proprioceptive mechanisms in body orientation and motor coordination. *Journal of Neurophysiology* 1961, 24:1-11.

Douglas, O. Kinesiology, kinesthetics and proprioception symposium. Warsaw, Va., Dec., 1970. Personal notes.

Frederick, RW. *How to study handbook*. New York: D. Appleton-Century, 1938.

Glover, VS. *Visual criteria for school design*. Paper presented at the Southeastern Council of Optometry, Atlanta, Ga., Feb. 5, 1961.

Grandjean, E. *Fitting the task to the man*. London: Taylor & Francis Ltd., 1969.

Harmon, DB. *Notes on a dynamic theory of vision*. Austin, Texas: By the author, Nalle Bldg., 1958.

Hirt, S. The tonic neck reflex mechanism in the normal human adult. *Am J Physic Med*, 1967, 46(1):362-369.

Larson, Leslie. *Lighting and its design*. New York: Whitney Publications, 1964.

Ott JN. *Health and light*. Old Greenwich, Conn.: Devin-Adair Co., 1973.

Ricci, B. *Physiological basis of human performance*. Philadelphia: Lea & Febiger, 1967.

Selye, H. *The stress of life*. New York: McGraw-Hill Book Co., 1956.

Wapner, S. and Werner, H. Experiments on sensory-tonic field theory of perception: V. Effect of body status on the kinesthetic perception of verticality. *J Exper Psych*, 1952, 44:126-131.

Waterland, JC. The supportive framework for willed movement. *Am J Physic Med*, 1967, 46(1):266-278.

Whipple, GM. *How to study effectively*. Bloomington, Ill. Public School Publishing Co., 1927.

**Amiel Francke** practices both general optometry and optometric visual training. In the field of optometric visual training he has lectured extensively, conducted seminars and contributed many articles to the literature. A 1946 graduate of Pennsylvania College of Optometry, he has served on the District of Columbia Board of Examiners in Optometry. He is COVD State Director, a Fellow of the American Academy of Optometry and chairman, Theoretical and Clinical Research Committee, Department of Research, OEP. He has also served as National Director and Middle Atlantic Seminar Chairman of OEP's Regional Clinical Seminar Program.

**Walter Kaplan** has a private practice in Gaithersburg, Md. He has authored papers on optometric training, lens application, reading development, behavioral optometry, and driver's vision. A 1944 graduate of Pennsylvania College of Optometry, Dr. Kaplan has served on the Board of Optometry of the District of Columbia. He has been OEP State Director and a member of the OEP Section on Theoretical and Clinical Research in Vision, Department of Research.

# Easier and More Productive Study and Desk Work

## Addenda

### Addendum 1

According to Dr. John Ott, a leading expert in lighting, the best fluorescent lighting fixture currently available is one made to his design and distributed by Environmental Lighting Concepts. Dr. Ott claims two advantages for this fixture. First, it has shielded terminals to block the radiation given off by all fluorescent tubes. Second, unlike other full spectrum lights which have ultra violet light built into the tube, this fixture has a separate ultra violet light. (It is Dr. Ott's opinion that the other tubes lose their ultra violet long before the tubes themselves burn out. The separate ultra violet light can be replaced when necessary, providing full ultra violet light, while the regular tubes can still be utilized for their full life.) This fixture uses G.E. Chromo #50 fluorescent tubes. If you do not want the ultra violet, you can use G.E. Chromo #50 tubes by themselves. They are available from any electric supply store. The other tubes mentioned in this article are now generally available and are superior to warm white; therefore, contrary to the advice given on page 3 of this article, do not use warm-white fluorescent tubes.

### Addendum 2

Both of Dr. Ott's books, *Health and Light* and *Light, Radiation and You*, are available from:

Devin-Adair Company  
6 North Water Street  
Greenwich, CT 06830

*Addenda 1 and 2 are from personal correspondence on February 13, 1989, from Dr. John Ott.*

**Addendum 3:** Where to obtain special items mentioned

- A. New Radiation-Shielded Full Spectrum Ott-Line Fluorescent Fixtures and Tubes  
Mr. Fred Mendelsohn  
Environmental Lighting Concepts  
3923 Coconut Palm Drive - 101  
Tampa, FL 33619  
(800) 842-8848.
- B. Full Spectrum Ultraviolet Transmitting Eyeglasses  
Wherever you ordinarily buy your eyeglasses, ask them to contact:  
Younger Optics  
3788 Broadway Place  
Los Angeles, CA 90007  
(213) 232-2345
- C. Ultraviolet Transmitting Contact Lenses  
Ask for the type of contact lens with the highest water content possible, which also meets your fitting and prescription needs.
- D. Fluorescent Fixture Shields, Louvers, and Grids; Ultraviolet Transmitting Plastic Windows and Skylights  
Manufacturers and brand names:  
Rohm and Haas " U.V.T. Plexiglas"  
American Cyanamid "Acrylite U.V.T."
- To locate products made from these materials, look in the Yellow Pages under Plastic Dealers or

R & R Plastics  
P.O. Box 1961  
Clifton, NJ 07015  
(201) 365-8083

Eggcrate (grid type) louver diffusers are available from:

Paraflex Industries, Inc.  
P.O. Box 920  
Beacon, NY 12508  
(914) 831-9000

or

Contact your local electrician

- E. Full Spectrum Fluorescent Tubes, which include the Ultraviolet Spectrum - brand names and manufacturers:

Vita-Lite  
Duro-Lite Lamps, Inc.  
Duro-Test Corp.  
2321 Kennedy Blvd.  
North Bergen, NJ 07047

Verilux  
Verilux, Inc.  
P.O. Box 1512  
Greenwich, CT 06836

*Both manufacturers claim that the deterioration of the ultra-violet spectrum as the bulbs age is negligible. Your local electrical wholesaler can get them for you, or you can write to the manufacturer for help. An inexpensive readily accessible source of these bulbs is:*

Simmons Co.  
54 Shallowford Road  
P.O. Box 3193  
Chattanooga, TN 37404  
(615) 622-1308  
(800) 533-6779

### Addendum 5

Some people using the inclined work surface have found they prefer no overhang, or an overhang of one or two inches, rather than the three or four inches

which is suggested in the text for Illustration #5. The overhang measurement is not critical. You can begin with a three or four-inch overhang, and, if that is not comfortable, saw off a little at a time until you reach the overhang measurement you prefer.

### **Addendum 6**

When doing stretching exercises do not bounce or do quick repetitions as described in this article. Instead, hold each stretch for a minimum of 10 seconds. You can then repeat several times, being sure that you always hold each stretch for the minimum 10 seconds. You can then repeat several times, being sure that you always hold each stretch for the minimum 10 seconds.

An excellent book on how to use stretching to reduce tension is:

***Stretching***

by Bob Anderson  
Shelter Publications Inc.  
Bolinias, CA

We recommend this book and suggest that you experiment with different stretches as described in the book to see which are the most effective for you. This book does not always recommend holding stretches for a minimum of 10 seconds. The knowledge that stretches should be held for that minimum period of time became available after the book was published.